

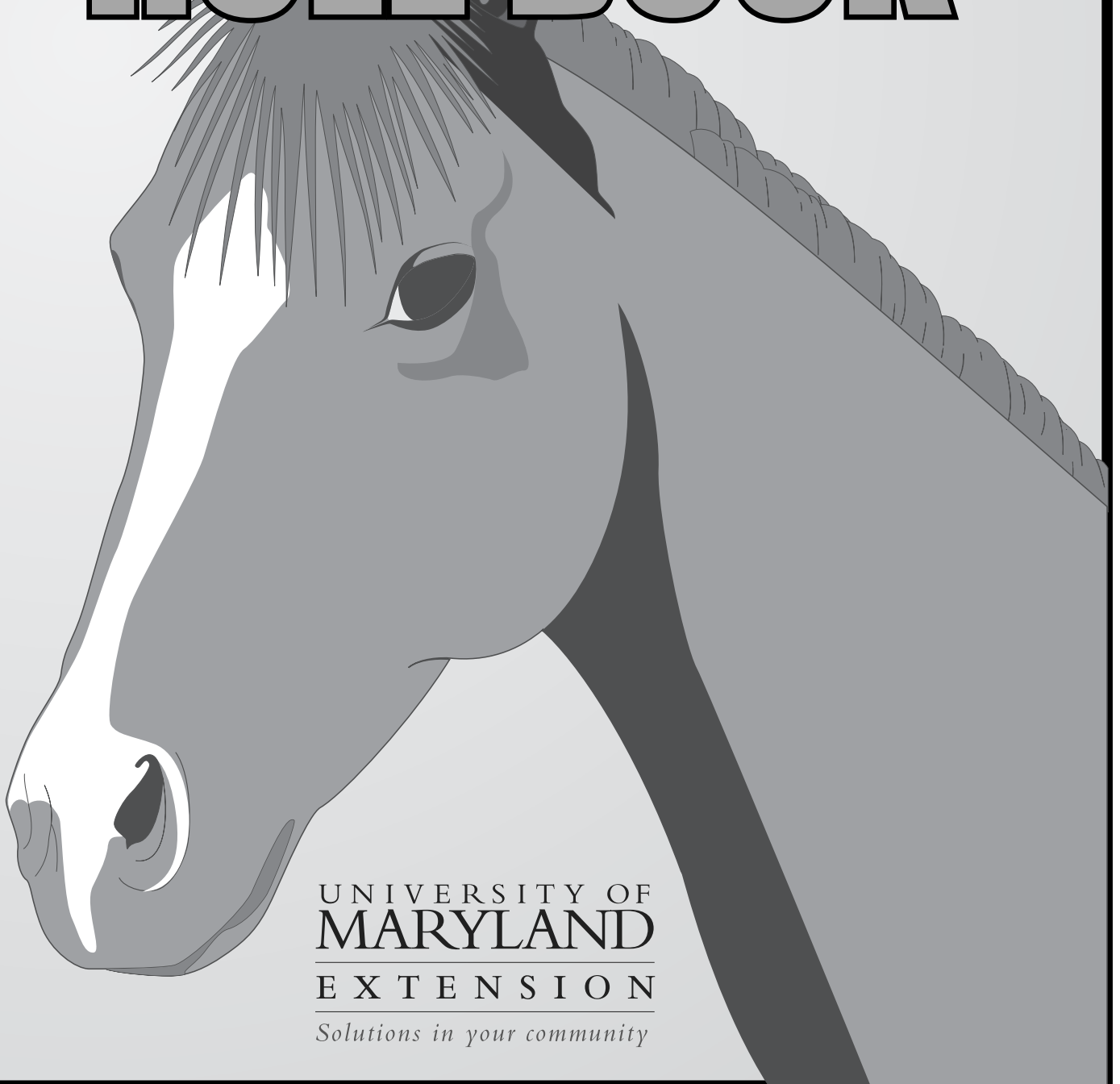

MARYLAND 4-H

4H 266

HORSE SHOW RULE BOOK



UNIVERSITY OF
MARYLAND
EXTENSION
Solutions in your community

THIS BOOK SUPERSEDES ALL PREVIOUS EDITIONS

THE RULES PUBLISHED HEREIN ARE EFFECTIVE MAY 1, 2009, AND REMAIN IN EFFECT EXCEPT AS SUPERSEDED BY ANY RULE CHANGES ENACTED BY THE MARYLAND 4-H OFFICE OR BY SUBSEQUENT EDITIONS OR SUPPLEMENTS TO THE RULE BOOK. PLEASE CHECK THE MARYLAND 4-H HORSE WEBSITE FOR ANY UPDATES TO THIS DOCUMENT.

www.4horse.umd.edu

In the case that an issue or situation arises that is not covered in this book, the rules of the Maryland Horse Show Association will apply for English shows and the rules of the American Quarter Horse Association will apply for Western Shows. The Maryland 4-H has received expressed permission by the Maryland Horse Show Association and the American Quarter Horse Association to reference their rule books.

Please direct all rule book inquiries to:

Maryland 4-H Center
8020 Greenmeade Drive
College Park, MD 20740
Phone: 301-314-9070
Fax: 301-314-7146
www.maryland4h.org

This document was revised by Amy Burk, Ph.D., Karol Dyson, and Paige Merriam and approved by the Maryland 4-H Animal Science Curriculum Committee, October 2005.

This document was revised by Kristen M. Wilson and Karol Dyson, May 2008.

This document was revised by Kristen M. Wilson, April 2009.



MARYLAND 4-H HORSE SHOW RULE BOOK



TABLE OF CONTENTS

	Page
I. Purpose	1
II. Eligibility -Exhibitors	1
III. Eligibility -Horses	1
IV. Safety, Liability, and Insurance	2
V. General Rules	2
VI. Show Organization and Management	3
VII. Fitting and Showing	4
VIII. Conformation	5
IX. English Division	5
1. General Rules for Over Fences Classes	5
2. Hunter	5
a. Attire	5
b. Tack	5
c. Hunt Seat Equitation	6
d. Hunter Under Saddle	6
e. Working Hunter Over Fences	6
f. Handy Hunter Over Fences	6
3. English Pleasure	6
a. Attire	6
b. Tack	6
c. English Pleasure Seat Equitation	6
d. English Pleasure Under Saddle	6
e. English Pleasure Over Fences	6
f. English Pleasure Command Break and Out	7
X. Western Division	7
1. General	7
2. Performance Classes	7
a. Horsemanship	7
b. Stock Seat Equitation	7
c. Western Pleasure	8
d. Western Riding	8
e. Reining	8
f. Working Western Horse	9
g. Trail	9
h. Western Command Break and Out	10
3. Timed Classes	10
a. General	10
b. Keyhole Race	11
c. Pole Bending	11
d. Barrel Race	12
Appendix A: Western Riding Patterns	13
Appendix B: Reining Patterns	14
Appendix C: Working Western Pattern	15
Rule Change Form	16



I. Purpose

1. The purpose of Maryland 4-H Horse Program activities is to provide opportunities for youth to develop life skills through participation in the horse project. Educational emphasis of the Maryland 4-H State Horse Show is on safety, sportsmanship, stable management, horsemanship, and showmanship.
2. The purpose of the Maryland 4-H State Horse Show rule book is to serve as a set of uniform rules and regulations for 4-H members participating in the Maryland 4-H Horse Show. It is recommended that the rules and regulations found in this rule book be utilized for local shows and events sponsored by clubs participating in the Maryland 4-H Horse Program.
3. All 4-H horse show participants are responsible for becoming familiar with and complying with the rules set forth in this rule book. If a matter cannot be solved by interpreting the rules to the letter, the Maryland 4-H State Horse Show superintendent will adopt a solution that follows as nearly as possible the purpose and objectives of the Maryland 4-H Horse Program.

II. Eligibility-Exhibitors

1. All exhibitors must be 4-H members currently enrolled in the 4-H horse project. A 4-H member must be between 8 and 18 years of age as of January 1 of the current year.
2. Age divisions are set up as follows: juniors (8-10 yrs. old), intermediates (11-13 yrs. old), and seniors (14-18 yrs. old) as of January 1 of the current year.
3. In order for 4-H members to be eligible to compete in the Maryland 4-H State Horse Show, the member must meet the following requirements:
 - a. be a 4-H member in good standing enrolled in a 4-H horse project;
 - b. have completed a 4-H Project Record for their horse(s), as of January 1 of the current year and submitted it to the county 4-H office if the member showed horses/ponies at the Maryland 4-H State Horse Show in the previous year;
 - c. have a Maryland 4-H Club Horse & Pony Identification Card, 4-H 117, on file at the county 4-H office by June 1 of the current year for each animal to be shown at the Maryland 4-H State Horse Show; and
 - d. have successfully passed Maryland 4-H Horsemanship Knowledge and Riding Levels 1 & 2 and English or Western Riding Level 3. 4-Hers entering a jumping class must specifically pass English Riding Jumping Level 3. 4-Hers showing in halter or showmanship classes ONLY are required to have Knowledge Levels 1 & 2 and must have prior approval by their club leader and/or county extension educator. All rankings must be on file at the county 4-H office prior to the State Fair.
4. Participation will be limited to the number of exhibitors and animals that can show during the days designated to the Maryland 4-H State Horse Show at the State Fair as determined by the superintendent.

III. Eligibility-Horses

1. All exhibitors must own the horse or have a formal lease agreement filed with the county Extension office by June 1 of the current year. The 4-H horse project member must assume primary care and training for their mount at all times.
2. A horse shown as a 4-H project animal can be shared by up to two 4-H members.
3. A horse shared by more than one 4-H member cannot be shown by more than one 4-H member in more than one Grooming and Showmanship or Conformation class on the same day. In addition, a horse shared cannot be shown by more than one 4-H member in any single Performance class.
4. For show purposes, the age of any horse is computed assuming a birth date of January 1 each year. For example, a horse foaled in 2003 will be one year of age on January 1, 2004.
5. All horses must be healthy and serviceably sound. A veterinarian may be asked to examine any animal whose health is in question. Any horse showing impairment of vision, broken wind, or evidence of lameness may be removed from the class and refused an award.
6. Proof of negative Coggins test for Equine Infectious Anemia within 12 months of the Maryland 4-H State Horse Show must be presented at the time of registration.
7. Cross entering of horses or ponies between the English and Western Divisions or between the English Pleasure and Hunter classes within the English Division is not permitted for the Maryland 4-H State Horse Show.
8. Exhibitors approved to participate will be limited to a total of 4 animals in the Maryland 4-H State Horse Show. Class limitations may be enacted at the discretion of the superintendent if necessary.
9. The term "horse" as used in these rules denotes either a horse or a pony, except when the term is used in class lists where height is one of the qualifications of the class.
10. Height divisions for Hunter and English classes will be:
 - a. Small Pony: 12.2 hands and under;
 - b. Medium Pony: over 12.2 hands and not exceeding 13.2 hands;
 - c. Large Pony: over 13.2 hands and not exceeding 14.2 hands;
 - d. Horse: over 14.2 hands.
11. Height divisions for Western classes will be:
 - a. Pony: under 14.1 hands;
 - b. Horse: 14.1 hands and over.



12. Ponies may be entered in classes designated for larger sized ponies or horses, but they must continue to be shown at that height division for the remainder of the Maryland 4-H State Horse Show.
13. In classes restricted to ponies, no animals may be shown in a Performance class unless the owner possesses a measurement card issued by the United States Equestrian Federation (USEF), Maryland Horse Show Association (MHSA), Maryland 4-H, or a recognized horse show association. Every pony must be measured each year until it reaches the age of 6.
14. Stallions may compete in the foal classes only.
15. No horse is permitted on the grounds unless it is participating in a scheduled 4-H horse activity for which it is registered.

IV. Safety, Liability, and Insurance

1. The safety and well-being of all persons and horses participating in the Maryland 4-H State Horse Show are serious concerns of the show management. Therefore, show management will give careful consideration to safety precautions to the fullest extent possible in keeping with good horsemanship and good judgment.
 2. Horseback riding is a potentially dangerous activity and assumption of risk is inherent. Safety is a responsibility of all exhibitors.
 3. Any exhibitor involved in any activity endangering a horse, rider, or spectator is subject to expulsion from the Maryland 4-H State Horse Show by the superintendent in consultation with show staff.
 4. In any class, the judge, superintendent, or steward can require the removal or alteration of any equipment that they deem unsafe or inhumane; two minutes allowed.
 5. No rider may be attached to the saddle by any means.
 6. Exhibitors must wear suitable hard soled closed toe shoes or boots, with heels when mounted, at all times while in the barn and show ring areas, both mounted and on the ground-NO EXCEPTIONS. Both English and Western riders must wear properly secured headgear passing American Society of Testing Materials (ASTM) and Safety Engineering Institute (SEI) standards at all times while mounted, including schooling. Headgear must carry ASTM and SEI seals.
 7. Use of a cellular phone while mounted is prohibited.
 8. All exhibitors will be expected to follow stable management guidelines outlined in this rule book. Failure to comply or cooperate with Maryland 4-H State Horse Show staff could result in forfeiture of premiums and/or future participation privileges.
 9. Assistance/coaching from outside the ring will not be permitted.
 10. Trainers, coaches, leaders, and parents in the schooling and barn areas must wear suitable closed toe shoes or boots at all times. Lack of cooperation with this policy may result in dismissal from the show-grounds.
11. The Maryland 4-H State Horse Show staff or other show officials cannot be held responsible for any accidents or damages to property or injuries that occur to participants, spectators, or other persons. A parent or guardian is required to sign a statement recognizing that neither the show staff nor the University of Maryland System staff or faculty members are liable for any accident or injury that may occur at state horse shows.

V. General Rules

1. Exhibitors at the Maryland 4-H State Horse Show must comply with general rules and horse show rules specified in the Maryland State Fair premium book.
2. Attire for showing and schooling should be clean, neat, attractive, fitted, and appropriate for the class or work for which it is worn (such as approved headgear, hard-sole shoes with heels, and long trousers). Traditional attire and conventional 4-H uniforms are equally acceptable in all classes. 4-H Uniforms consist of white or tan shirt or blouse; white, green, or tan skirt or pants; green or black tie; and hard soled shoes or boots, with heels. These qualities contribute to the impression made by the exhibitor and the show. Exhibitors may be excused for inappropriate attire at the discretion of the judge.
3. All tack must be clean, fitted to the horse, and in good repair.
4. The fitting, preparation, and showing of all horses is the responsibility of the Exhibitor. Exhibitors may receive guidance only from immediate family members, Maryland 4-H Members, and appointed MCE Volunteers.
5. Horses and ponies may only be ridden by the Exhibitor unless expressly permitted by the superintendent, steward, or stable manager.
6. A written protest may be lodged by an exhibitor or his or her parent or leader, if:
 - a. signed by the exhibitor's parents and/or guardian or leader;
 - b. addressed to the superintendent;
 - c. accompanied by a deposit of \$250, which is refundable if the Maryland 4-H State Horse Show management staff, Maryland Fair Board, or 4-H State Fair Review Board decides in favor of protestor; and
 - d. received by the superintendent within 24 hours of the incident in question.
7. Riding is not permitted inside the barns or outside the immediate barn area. The show ring and/or practice ring may only be used for exercising and schooling when announced. Horses must be saddled and bridled at all times when being ridden.
8. In all classes where entries are worked individually, it is the responsibility of the exhibitor to be at the ring ready to show when their class is called.



9. A fall of horse or rider in any class will result in the exhibitor being excused from that class.
10. Stable management guidelines:
 - a. Exhibitors must check in with Stable Manager upon their arrival and check out with Stable Manager upon their departure.
 - b. Buckets and decorations must be hung with ties, cords, or screw-eyes that can be easily applied and removed and are safe for the horse. No nails or screws can be used to attach decorations, buckets, hay nets, to any stalls at the State Fairgrounds.
 - c. Exhibitors should keep their stalls clean and well bedded, with fresh water and either loose or block salt available at all times.
 - d. An exhibitor must ensure that his or her animal's stall and general barn area is clean before being released. Violators will have their premiums withheld.
 - e. Horses should be cooled and brushed after exercise.
 - f. Exhibitors will not be permitted to groom animals in barn aisles. All animals must be groomed in stalls.
 - g. All stabling problems should be directed to the Stable Manager.
 - h. Exhibitors must post emergency contact information and horse identification information on their stalls.
 - i. Dogs are not permitted in the barn and riding ring area.
 - j. All manure and used shavings removed from stalls or trailers must be placed in specific designated areas.
 - k. Smoking is NOT permitted in any buildings, rest rooms or stable areas.
 - l. Maintain clean facilities and grounds during scheduled events, place litter in trash receptacles, keep aisles clean and open in accordance with fire regulations.
 - m. In an effort to reduce the spread of infectious equine disease, competitors are strongly discouraged from allowing physical contact among horses and/or the sharing of tack, equipment, feed, and water among horses. Exhibitors are also advised not to allow their horse to consume feed and/or forage (i.e., hay and pasture) that was not brought by the exhibitor.
11. All exhibitors must sign the "Maryland 4-H Code of Animal Science Ethics" prior to the event.
12. In accordance with the Maryland 4-H Code of Animal Science Ethics, no horse may be shown in any class if it has been administered, in any manner, any stimulant, depressant, or local anesthetic that might affect performance or conformation.
13. Cruelty, rough handling, or mistreatment of a horse deemed by the Maryland 4-H State Horse Show staff shall be grounds for disqualification of an exhibitor by the steward or show superintendent.

14. Exhibitors and spectators must display good sportsmanship at all times. Any discourtesy by an exhibitor, parent, or leader displayed toward Maryland 4-H State Horse Show officials, other exhibitors, parents or leaders, may result in forfeiture of ribbons, trophies, and/or premiums, and or dismissal from the Maryland State Fair. Exhibitors are expected to honor the written intent and spirit of the Maryland 4-H Code of Animal Science Ethics at all times. Flagrant violations or discourtesies may result in the State 4-H Office banning an exhibitor from competing in future 4-H horse shows. Appeals are to be made to the steward by the exhibitor only. Judges may be approached by way of the steward or superintendent only.

VI. Show Organization and Management

1. The show organization should include the following components:
 - a. **Superintendent:** coordinates all phases of the show, appoints all show management staff, and assists all personnel in carrying out their duties.
 - b. **Steward(s):** shall be appointed by the superintendent for English and Western Divisions. Stewards will be available to judges, exhibitors, and the show management staff at all times during the show to clarify and interpret the Maryland 4-H Horse and Pony show rules. They shall not associate in any way with 4-H exhibitors or spectators. Stewards shall not act as timers or starters, nor serve in any capacity other than steward. Other duties of the steward shall include, but not be restricted to: (1) protecting the interests of exhibitors, judges, and show management staff; (2) reporting to the show management staff any error or misrepresentation in regard to any entry; (3) verifying the measurement of all horses for which heights are questioned; (4) reporting in writing serious violations to the superintendent. The show management staff will act upon complaints regarding violation of the rules. Written copies of these complaints may be forwarded for review by the State 4-H Office.
 - c. **4-H State Fair Review Board:** the 4-H State Fair Review Board has the authority to rule in the case of violation of all Rules and Regulations pertinent to the 4-H animal shows, competitions, and associated activities at the State Fair.
 - d. **Judge(s):** evaluates participants and their horses in conformity with the rules and specifications of each class as it appears in this rule book.
 1. The judge should observe and disqualify or penalize participants for any improper, excessively severe or unsafe riding or unsafe equipment as well as horses in poor health and/or condition.
 2. The judge may use a scorecard, and is permitted to use any system of recording he or she deems appropriate to place the class.
 3. The decisions of a judge shall be deemed final unless in direct violation of rules. Any questions about these decisions must be directed to the steward by the exhibitor or show superintendent only. No exhibitor or spectator has the right



to inspect the judges' cards. Judges are encouraged to give oral reasons on all classes, particularly for Grooming and Showmanship classes.

4. Judges shall not be responsible for decisions regarding the management of the show. Judges should inspect hunter courses, Western riding patterns, etc., after they have been set. A judge must order any horse from the ring whose actions are unruly or threaten the safety and performance of other exhibitors or their horses.
- e. **Ringmaster:** assists the judge and show management staff in getting classes into the ring, lining up horses, and recording placings. The ringmaster shall not consult with the judge about placings.

VII. Fitting and Showing-All Divisions

1. The purpose of the fitting and showing class is for the exhibitor to show the horse to its best advantage. The class will be judged with emphasis on the exhibitor's ability to handle and show their horse. The horse's conformation and breed character is not judged.
2. The exhibitor must prepare their horse prior to the class without assistance except for when holding the horse is necessary. Any violation is the basis for disqualification from Grooming and Showmanship competition.
3. Attire: Clothing appropriate for the division or conventional 4-H uniforms are equally acceptable in Fitting and Showing classes. Chaps and spurs are not permitted.
 - a. **Western:** Exhibitor must wear a Western hat or protective headgear, Western boots, a long-sleeved shirt with a collar (including standup, tuxedo, oxford, button-down, and turtleneck), and long pants. If the pants have belt loops, a belt must be worn. Gloves, bats, or crops are optional.
 - b. **Hunter:** Exhibitors must wear hunt-style jackets or blazers. Conservative colors including black, blue, hunter green, or brown are recommended. Riding breeches and hunt boots, or jodhpurs with jodhpur boots are required. Garters or legging straps are recommended. Recommended colors for breeches and jodhpurs include tan, gray, or khaki. Approved protective headgear is required. Shirts with stock and pin or ratcatcher and choker are required for females. Male exhibitors are required to wear a button-down collar shirt with tie. Crops or bats are optional.
 - c. **English Pleasure:** Saddle suit or coat and jodhpurs of conservative colors are recommended. Clothing must include Kentucky jodhpurs that match or coordinate with the jacket; a tie; a derby, soft hat or protective headgear; and jodhpur boots. Whips, gloves, and small boutonnieres are optional.
4. **Tack:** Appointments of the horse for the various divisions are as follows:
 - a. **Western:** Leather show halter and leather shank or any properly fitting halter with shank. Silver on halters will not serve as an advantage. Chain shanks may be used either under the chin or over the nose for safety reasons.
 - b. **Hunter:** Hunter type bridle and an approved bit (see Section IX. English Division) of exhibitor's choice. Halters may be used on horses under the age of two. Braiding is optional, but recommended for senior exhibitors.
 - c. **English Pleasure:** Suitable bridle with an approved bit (see Section IX. English Division) or halter, depending on breed. Halters may be used on horses under the age of two regardless of breed or type. Ribbons are optional and may be either clipped or braided into mane.
5. **Scoring:** The basis of scoring Fitting and Showmanship classes is:
 - a. Showmanship: 50%
 1. Execution of the pattern
 2. Posing/Set up for inspection
 3. Poise and alertness of exhibitor
 4. Knowledge of information pertaining to the exhibitor's horse project
 - b. Appearance: 50%
 1. Cleanliness of horse and rider
 2. Trimming and braiding
 3. Physical condition
 4. Appropriate, clean, and properly fitted tack
 5. Appropriate attire of exhibitor
6. **Showing Procedures:**
 - a. Patterns will be posted at least 1 hour prior to class time. Questions regarding the pattern should be directed to the steward or superintendent prior to the commencement of the class. Showing horses in the quarter system is recommended. This method allows the judge an unobstructed view of the horse and it allows the exhibitor the ability to monitor the horse at all times. Regardless of the showing style, the exhibitor should keep the judge within his field of vision at all times and should never stand directly in front of the horse.
 - b. The exhibitor shall always lead the horse from the horse's left (near) side and all turns more than 90¹/₄ shall be to the right with the exhibitor walking to the right around the horse.
 - c. The right hand should be on the lead shank or reins about eight to twelve inches from the halter or bit. Method of holding the excess lead shank or reins is optional, but should be held in the



left hand in a safe manner. When using a shank, the exhibitor's hand should not touch the chain of the shank.

- d. When asked to move horse toward or away from judge, the horse should be kept in a straight line. The horse, not the exhibitor, should be aligned with the judge.
 - e. When asked to show at the walk or trot, horses should move off promptly and be shown at a brisk pace. Exhibitors should be positioned alongside the horse between the throat latch and shoulder.
 - f. When asked to return to the line-up, exhibitor should go through the line of horses (if standing side by side) and pivot beyond the line of horses for safety and space needed in the turn around.
 - g. Exhibitors should pose their horses according to division and/or breed type and maintain that pose for the duration of the class.
7. The judge will select a Junior, Intermediate, and Senior Champion (no Grand Champion will be selected). Junior and Intermediate Champions in the Maryland 4-H State Horse Show will not be eligible for Fitting and Showing competition until they reach the next age division. Senior Champions in Fitting and Showing will not be eligible to compete in the same class in future state shows.

VIII. Conformation-All Divisions

1. In conformation classes, the horse is shown in hand and it is judged on conformation, way of going, quality, breed character, condition, soundness, and blemishes. In appraising and ranking each horse, the judge relates form to function.
2. Tack and attire is consistent with what is outlined in the Fitting and Showing Division.
3. Broodmares and foals are shown at a walk only.
4. In classes of mares with foal by their sides, the foal must accompany the mare.
5. All lame horses shall be excused from the ring prior to final placings by the judge.
6. Horses are allowed only one handler in each class. For mares and foals, the exhibitor will show the animal being judged, while another 4-H member of the same age or younger may be the handler for the second horse.
7. A Junior Champion and a Reserve Junior Champion will be designated in classes for foals, yearling ponies, and yearling horses. A Champion mare and Reserve Champion mare will be designated from the mare classes; similarly a Champion and Reserve Champion gelding will be selected from the gelding classes. First place class winners show for Champion competition. The horse that placed second in the class from which the Champion was selected will compete with the remaining first place winners for Reserve Champion.

IX. English Division

1. General Rules for Over Fences Classes

- a. Courses will be determined and posted by the show management. A course consists of six or more fences. Fences should simulate obstacles found in the hunting field, including but not limited to post and rails, brush, white board fences or gates, and coops. All fences should be at least 10 feet wide, with adequate wings. The suggested distance for an "in-and-out" is 24 to 26 feet for horses, 24 feet for large ponies, 22 feet for medium ponies, and 20 feet for small ponies.
- b. In all classes over fences, the performance starts when the horse or pony enters the ring and ends when they leave the ring. Circling once upon entering and once upon leaving is permissible, but not required.
- c. In case of a refusal or runout at a double or triple, the exhibitor shall re-jump all elements of the combination.
- d. Judges shall penalize extreme speed, unsafe jumping and poor form over fences, whether touched or untouched.
- e. Ticks are not counted as faults except when they are the result of poor jumping.
- f. Elimination results from the following: jumping an obstacle before it is reset, failure to stay on course, a fall of horse and/or rider, or three refusals. A horse is considered to have fallen when shoulder and haunch on the same side touch the ground or the obstacle and the ground.
- g. The judge may ask exhibitors to jog horses to evaluate soundness.

2. Hunter

- a. **Attire:** All riders are required to wear ASTM- and SEI-approved helmet with harness secured and hard soled shoes with heels. Traditional attire and conventional 4-H uniforms are equally acceptable. Traditional apparel includes breeches or jodhpurs, boots, jacket, suitable shirt, tie or choker. Spurs (unrowelled, not to exceed 1 inches in length), and a crop or bat (not greater than 30 inches in length) are optional.
- b. **Tack:** It is recommended that the bridle be a light show type with a snaffle, pelham, kimberwick, or full bridle. Nosebands should be made entirely of leather, and dropped, figure 8, or flash nosebands are prohibited. Biting preference will be left to the discretion of the judge. Double reins or converters are required on pelham or full bridles. Breastplates and martingales are optional in classes over fences. Martingales are prohibited in under saddle classes. In the event of broken equipment, the rider may continue without penalty. If the rider stops and corrects the difficulty, he or she will be penalized. The judge may penalize or excuse a horse with unconventional equipment.



c. Hunt Seat Equitation

1. Only the rider is being judged, therefore any horse that is suitable and is capable of performing the required class routine in a safe manner is acceptable.
2. The rider should have a workmanlike appearance, seat and hands light and supple, maintaining balance and coordination and conveying the impression of complete control should any emergency arise.
3. Under Saddle: riders will show at the walk, trot and canter, both ways of the ring. Exhibitors may be asked to back, perform a sitting trot, extended trot, hand gallop and halt, demonstrate change of diagonals or lead, perform without stirrups or execute a pattern.
4. Over Fences: horses and ponies may be in the same class, but will jump fences of different heights. For Juniors and Intermediates, fences will be set at 2 feet for small and medium ponies. Fences will be set at 2 feet 6 inches for large ponies and horses. For Seniors, fences will be set at 2 feet 3 inches for small and medium ponies. Fences will be set at 2 feet 9 inches for large ponies and horses. Types of jumps will be left to the discretion of the show management staff.

d. Hunter Under Saddle

1. The horse, not the rider, will be evaluated based on the following criteria: performance, way of going, consistency, suitability, and obedience. Credit will be given to a horse that is relaxed, forward moving, balanced in its way of going, and responsive to the rider.
2. Horses will be shown at a walk, trot and canter, both ways of the ring.
3. The judge may ask for a hand gallop, but never more than eight horses at one time. When asked, horses should back easily and stand quietly.

e. Working Hunter Over Fences

1. Horses will be judged on an even hunting pace, manners, jumping style together with faults and way of moving over the course.
2. To be shown over eight or more jumps. Fences will be set at 2 feet for small ponies, 2 feet 3 inches for medium ponies, 2 feet 6 inches for large ponies, and 2 feet 9 inches for horses.

f. Handy Hunter Over Fences

1. Horses will be judged on performance, navigation of course, promptness, jumping form, and way of going as well as suitability for actual use in the hunting field.
2. The course may have at least two changes of direction and at least one combination of fences. Horses may be asked to trot one fence and or halt during the course.

3. To be shown over eight or more jumps. Fences will be set at 2 feet for small ponies, 2 feet 3 inches for medium ponies, 2 feet 6 inches for large ponies, and 2 feet 9 inches for horses.

3. English Pleasure

- a. **Attire:** Tack and attire should suit the horse and style of riding (i.e., Hunter Pleasure, Saddle Seat, Sidesaddle). ASTM-and SEI-approved headgear with harness secured is required in all classes.
- b. **Tack:** The bridle will be light show type with snaffle, curb, kimberwick or pelham bit, or full double bridle. Nosebands should be made entirely of leather, and double reins or converter are required on all full or pelham bridles. Martingales, dropped and flash nosebands, figure 8 nosebands, Western saddles, rowelled spurs, weighted shoes, boots, and built-up pads are prohibited.

c. English Pleasure Seat Equitation

1. Only the rider is being judged, therefore any horse that is suitable and is capable of performing the required class routine in a safe manner is acceptable.
2. The rider should have a workmanlike appearance, seat and hands light and supple, maintaining balance and coordination and conveying the impression of complete control should any emergency arise.
3. Riders will show at the walk, trot (or similar gait) and canter, both ways of the ring. Exhibitors may be asked to back, perform a sitting trot, perform an extended trot, or demonstrate change of diagonals or lead.

d. English Pleasure Under Saddle

1. This class is for horses and ponies of any breed. Horses will be judged on performance, willingness, suitability to purpose and soundness, with emphasis on manners.
2. Horses will be shown at a walk, trot (or similar gait) and canter, both ways of the ring. The rider may be asked to extend or collect at the trot and/or canter. The horse should stand quietly and back readily.

e. English Pleasure Over Fences

1. Horses will be judged on performance with emphasis on manners over a jumping course. Horse may be asked to halt and/or back during the course.
2. The horse will be shown over a course of 8 fences. Fences will be set at 2 feet for ponies, and 2 feet 6 inches for horses.



f. English Pleasure Command Break and Out

1. Horses are judged on their prompt obedience in performing commands called by the judge.
2. The judge should be positioned outside and at a level above the arena to allow them to properly view the class. Efforts should be made to provide the judge with a microphone so that he or she can issue commands and call out riders promptly.
3. Rules for this class and any unusual commands must be dictated by the judge and read by the announcer prior to the class. Only the judge shall eliminate entries.
4. A command should be executed within three (3) strides. When asked to reverse, the horse should maintain the current gait. When asked to back, the horse should continue until told to stop (halt). When asked to reverse at the canter, the horse should change lead unless otherwise specified. When asked to reverse at the rising trot (posting), the rider must change diagonals.

- e. The rider's hands must be clear of horse and saddle when horse is in motion. Two-handing or touching the saddle will be severely penalized. Except in timed (speed) classes and where appropriate in trail classes, only one hand may be used on reins and hands must not change. The rider of a junior horse may use two hands on the reins if using a snaffle or a bosal. When split reins are used, one finger is permitted between the reins. When using a romal, no finger is allowed between the reins. Two-handing reins, a finger between romal reins, or more than one finger between split reins is incorrect and will result in a penalty.
- f. Horses must reverse toward the inside of the ring, away from the rail.
- g. Use of a bat, crop, spur, whip, or rope in front of the cinch will result in disqualification. Excessive use of the above will be penalized.
- h. Classes are offered at the discretion of the Show Committee. Not all classes may be available each year. Class offerings will be determined by interest and skill level of riders over a several year period.

2. Performance Classes

a. Horsemanship

1. The rider (not the horse) will be judged on hands, seat, balance, control, suitability, and general performance at the walk, jog, and lope. The rider should maintain a balanced seat at all gaits, without excessive weight in the stirrups. The heels should be lower than the toes. The body should appear comfortable, relaxed, and flexible. Reins should be held in accordance with rules governing equipment used/ age of horse. The rider should maintain light contact with the horse's mouth.
2. Riders will work both ways of the ring at a walk, jog, and lope. The rider should demonstrate his or her ability to have the horse on the proper leads. The rider will be asked to back his or her horse.

b. Stock Seat Equitation

1. The rider (not the horse) will be judged on hands, seat, balance, control, suitability, and general performance at the walk, jog, and lope. The rider should maintain a balanced seat at all gaits, without excessive weight in the stirrups. The heels should be lower than the toes. The body should appear comfortable, relaxed, and flexible. Reins should be held in accordance with rules governing equipment used/ age of horse. The rider should maintain light contact with the horse's mouth.
2. Riders will work both ways of the ring at a walk, jog, and lope. The rider should demonstrate his or her ability to have the horse on the proper leads. The rider will be asked to back his or her horse.
3. After riders have worked in a group, the riders will individually perform a pattern. The maneuvers could include

X. Western Division

1. General

- a. Attire: Exhibitor must wear ASTM-and SEI-approved headgear when mounted. Traditional attire and conventional 4-H uniforms are equally acceptable in all classes. Traditional attire includes Western boots, a long-sleeved shirt with a collar (including standup, tuxedo, oxford, button-down, and turtleneck), and long pants must be worn. If the pants have belt loops, a belt must be worn. No whips or crops may be carried. Gloves, spurs, and chaps are optional. If spurs are used, the rowels must be blunt and turn freely. A judge may penalize for excessive use of spurs.
- b. Tack: A properly fitted Western (stock) saddle and Western bridle are required. Safety stirrups are permitted. The judge may penalize or excuse a horse with nonconventional equipment.
- c. Horses may be shown in curb, half-breed or spade bits (shank not to exceed 8 1/2 inches). Curb chains or curb straps should be used with a shanked bit. The chain must be a flat-type chain link, one-half inch or wider, lying flat against the chin. It must be adjusted to permit the entry of two fingers or more between the curb and the chin. No wire or rawhide device, regardless of how padded or taped, may be used in conjunction with, or as part of, the chin strap. If a romal is used, hobbles must be attached to the saddle. A junior horse aged 5 years old or under may be ridden in a snaffle or bosal.
- d. The following are prohibited in all classes except for speed events: Protective boots or leg wraps, tapaderos, crops, bats, martingales (tie-downs), nosebands, and mechanical hackamores.



figure 8's, square stops, circles, pivots, backing, and riding without stirrups.

c. Western Pleasure

1. The horse, not the rider, will be evaluated based on the following criteria: manners, quality, way of going, and consistency. Credit will be given to a horse that is relaxed, balanced in its way of going, and responsive to the rider.
2. This class is open to horses of any breed or combination of breeds that may be used for pleasure.
3. Horses are to be shown both ways of the ring at walk, jog, and lope on a reasonably loose rein without undue restraint. Horse may be asked to back.
4. The horse's head should be carried in a natural position consistent with its breed standard. The horse should not be overflexed at the poll nor excessively nosed out. The poll should not drop below the level of the withers for more than two strides.

d. Western Riding

1. Western riding is judged based on the following criteria: quality of gaits, lead changes at the lope, response to the rider, manners, and disposition. The horse should perform with reasonable speed and be sensible, well-mannered, and free moving.
2. **Pattern:**
 - a. Each exhibitor will perform the required pattern individually. Any horse not following the posted pattern will be disqualified (Appendix A).
 - b. Markers should be spaced uniformly at distances no less than 30 feet and no more than 50 feet apart.
 - c. Markers should be set a minimum of 15 feet from the fence or wall, and a minimum of 50 feet, but no more than 80 feet across the pattern.
3. **Scoring:**
 - a. Will be conducted in accordance with AQHA rules. For detailed specifics regarding this class, please see the most current AQHA rule book.
 - b. Scoring will be on a basis of 0 to 100 with 70 denoting an average performance. Final placings are determined on cumulative score.
 - c. Maneuver scores will be determined independently of penalty points. Each maneuver is scored from -1.5 to 1.5 with a score of zero being correct/average. The following are considered faults and will be judged accordingly in maneuver scores: opening mouth excessively, anticipating signals, and stumbling.

- d. Penalty points range from 0.5-5 points depending on the severity of the disobedience.
- e. Credits will be given for the following: change of lead hind and front simultaneously, changes of leads at the center point of the lead change area, accurate and smooth pattern, even pace throughout, easy to guide and control with rein and leg, manners and disposition, conformation and fitness.
- f. Disqualification (zero score) will result from the following: illegal equipment, willful abuse, off course, knocking over markers, major refusal-stop and back more than two strides (four steps) with front legs, major disobedience-rearing or schooling with two hands.

e. Reining

1. Reining is a class that tests the horse's maneuverability and athleticism while completing a pattern consisting of circles, lead changes, spins, stops, rollbacks, and backing.
2. **Patterns:**
 - a. Each exhibitor will individually perform one of the reining patterns listed in this rule book (Appendix B).
 - b. The judge will select and post the pattern at least one hour prior to the start of the class.
 - c. All horses will be judged immediately upon entering the arena and judging will cease after the last maneuver is performed.
3. **Scoring:**
 - a. Will be conducted in accordance with AQHA rules. For detailed specifics regarding this class, please see the most current AQHA rule book.
 - b. Scoring will be on a basis of 0 to infinity with 70 denoting an average performance. Final placings are determined on cumulative score.
 - c. Maneuver scores will be determined independently of penalty points. Each maneuver is scored from -1.5 to 1.5 with a score of zero being correct/average. The following are considered faults and will be judged accordingly in maneuver scores: opening mouth excessively, excessive head raising on stop, lack of smooth straight stop on haunches (bouncing or sideways stop), refusing to change leads, anticipating signals, stumbling, backing sideways, knocking over markers, losing a stirrup, and failure to go beyond markers on rollbacks and stops.
 - d. Penalty points range from 0.5-5 points depending on the severity of the disobedience.



- e. Credits will be given for the following: smoothness, finesse, attitude, quickness, and authority in performing the various maneuvers while using controlled speed.
- f. The following will result in no score/disqualification: willful abuse of animal or evidence that an act of an abuse occurred prior to or during the competition, use of illegal equipment, use of any attachment that alters the movement or circulation to the tail, failure to provide horse or equipment to the judge at the end of the pattern.
- g. The following will result in a score of zero: use of more than one finger between the reins, use of two hands (except on junior horses) or changing hands, failure to complete pattern as written, performing the maneuvers other than in specified order, inclusion of maneuvers not specified, equipment failure that delays completion of pattern including dropping a rein onto the ground while horse is in motion, balking or refusal of command where pattern is delayed, running away or failing to guide where it becomes impossible to discern whether the exhibitor is on pattern, jogging in excess of 1/2 circle or 1/2 the length of the arena, overspins of more than 1/4 turn, fall to the ground of horse and/or rider.
- h. Exhibitors receiving a no score or a zero score are not eligible to place in a class.

f. Working Western Horse

1. Working Western Horse is a class that is judged on quiet, controlled negotiation of an individual pattern. Manners and obedience to the rider will be evaluated.
2. **Pattern:**
 - a. Each exhibitor will perform the pattern listed in this rule book (Appendix C).
 - b. All horses will be judged immediately upon entering the arena. Judging will cease after the last maneuver.
 - c. Pattern should be completed well off the rail.
3. **Scoring**
 - a. Horses are to be scored on each component of the pattern.
 - b. Horses will be scored according to the following scale:
 - 4 Excellent
 - 3 Good
 - 2 Average
 - 1 Below average
 - 0 No execution of maneuver

- c. Omitting a maneuver will not result in disqualification, but the omitted maneuver receives a score of 0.
- d. An exhibitor unable to negotiate a maneuver may be motioned on to the next maneuver at the discretion of the judge. This will not occur until the rider has attempted the maneuver 3 times unsuccessfully.
- e. Riders taking excessive time in starting/completing a maneuver will be asked to move on and will receive a score of 0 for that maneuver.

g. Trail

1. The class will be judged on the performance of the horse over obstacles with emphasis on manners, response to the rider, and quality of movement.
2. **Obstacles:**
 - a. At least six (6) obstacles must be used, three mandatory obstacles and three optional obstacles.
 - b. Mandatory obstacles include: 1) opening, passing through, and closing gate; 2) riding over at least four logs; and 3) backing through an obstacle.
 - c. Optional obstacles may include: 1) water hazard (ditch or shallow pond); 2) serpentine obstacles at walk or jog; 3) carry an inanimate object from one part of arena to another; 4) ride over wooden bridge; 5) put on and remove slicker garment; 6) remove or replace materials from mailbox; 7) side pass; 8) turns of varying degrees (e.g., 180°, 360°) in an obstacle consisting of four logs or rails laid in a square; 9) any other safe and negotiable obstacles that could reasonably be expected to be encountered on a trail ride and meet the approval of the judge.
 - d. Unacceptable obstacles include: tires, animals, hides, jumps, rocking or moving bridges, water box with floating or moving parts, flames, dry ice, fire extinguishers, logs over poles elevated in a manner that permits them to roll.
 - e. Commands calling for riders to remount their horses in the ring are prohibited.
 - f. The judge must walk the course and has the right and duty to alter the course in any manner. If at any time a trail obstacle is deemed unsafe by the judge, it shall be repaired or removed from the course. If it cannot be repaired and horses have completed the course, the score for that obstacle shall be deducted from all previous works for that class.



3. **Scoring:**
 - a. Scoring will be on a basis of 0 to infinity with 70 denoting an average performance. Final placings are determined on cumulative score.
 - b. Maneuver scores will be determined independently of penalty points. The execution of maneuver is scored from -1.5 to 1.5 with a score of zero being correct/ average.
 - c. Horses should be penalized for any unnecessary delay while approaching or negotiating the obstacles.
 - d. Penalty points range from 0.5-5 points depending on the severity of the disobedience. Penalties include: ticking or knocking into any part of the obstacle; break of gait at walk or jog for more than 2 strides; skipping over or failing to step into a required space; split pole in lope-over; break of gait; out of lead or break of gait; knocking down any part of an obstacle; stepping outside the confines of, falling, or jumping off an obstacle; dropping inanimate object required to be carried; each refusal; letting go of gate or dropping rope gate; blatant disobedience (kicking, rearing, bucking, striking, etc.); failure to ever demonstrate correct lead or gait if designated; failure to complete obstacle; use of more than one finger between the reins; use of two hands (except on junior horses) or changing hands except as discussed below; lack of attempt of an attempt to complete an obstacle.
 - e. Refusals will be penalized. A refusal is defined as any action taken by the horse to avoid performing an obstacle. After three such refusals at any one obstacle, the exhibitor will be required to proceed to the next obstacle.
 - f. Changing hands on the reins to work an obstacle will be permitted only when correct negotiation of the obstacle requires it (e.g., open gate or mailbox, pick up object, etc.).
 - g. Credits will be given to horses negotiating obstacles with style and some degree of speed, providing correctness is not sacrificed. Horses should receive credit for showing attentiveness to the obstacle and the capability of picking their own way through the course when obstacles warrant it, and willingly responding to the rider's cues on more difficult obstacles.
 - h. The following will result in a score of zero or no score: performing the maneuvers other than in specified order; inclusion of maneuvers not specified, equipment failure that delays completion of pattern including dropping a rein onto the ground while horse is in motion, touching the horse on the neck to lower the head, or use of free hand to instill fear or praise, or riding outside the designated boundaries. Exhibitors receiving no score or a zero score are not eligible to place in the class.
 - i. For situations not covered by this rule book please consult the most current AQHA rule book.
- h. **Western Command and Out**
 1. Horses are judged on their prompt obedience in performing commands called by the judge.
 2. The judge should be positioned outside and at a level above the arena to allow them to properly view the class. Efforts should be made to provide the judge with a microphone so that they can issue commands and call out riders promptly.
 3. Rules for this class and any unusual commands must be dictated by the judge and read by the announcer prior to the class. Only the judge shall eliminate entries.
 4. A command should be executed within three (3) strides. When asked to reverse, the horse shall maintain the current gait. When asked to back, the horse shall continue until told to stop (halt). When asked to reverse at the canter (lope) the horse shall change lead unless otherwise specified.
3. **Timed Classes**
 - a. **General**
 1. The rider may have both hands on the reins during these performances. Reins may be split or single. If split reins are used, they must be tied or fastened together.
 2. Before beginning the course, the rider must be mounted and inside the ring, with the gate closed, and receive the recognition of the judge. No assistance to either horse or rider is permitted past the arena gate. Gate will remain closed until the horse has stopped or is walking.
 3. Horses will cross the starting line with a running start.
 4. Spurs, crops, bats, tapaderos, nosebands, martingales, and tie-downs are all optional.
 5. Use of a bat, crop, spur, whip, or rope in front of the cinch will result in disqualification. Excessive use of the above will be penalized.
 6. There will be a 5 second penalty for knocking over pattern markers (barrels, poles, cones, etc.).
 7. Failure to follow the course or fall of horse and rider in the arena shall cause disqualification.
 8. Timing procedures: An electric timer or at least two stopwatches shall be used, with the time indicated by the electronic timer or average time of the watches used by official timers to be the official time. Timing begins as soon as the horse's nose reaches the starting line and ends when the horse's nose passes over the finish line.

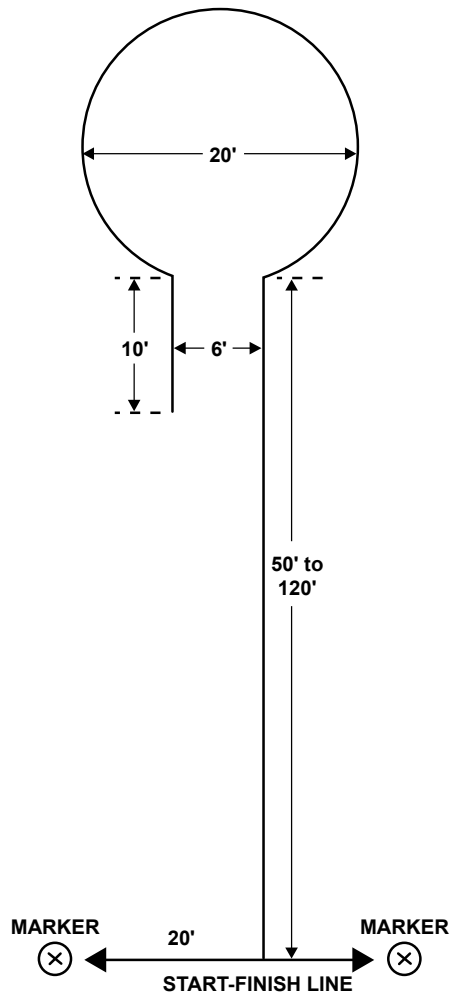

b. Keyhole Race

1. The course will be laid out with limed keyhole on the ground with the opening of the keyhole facing the starting line (see pattern below). The center of the circle should be approximately 100 feet from the timing line. The keyhole will be in the form of a broken circle 20 feet in diameter with an entrance lane 6 feet wide and 10 feet long.
2. The horse must proceed through the entrance lane, turn right or left in the circle, and return through the lane.
3. A horse is disqualified if it 1) steps on or over the keyhole chalk lines including the lane as determined by the judge, or 2) fails to cross the start/finish line.

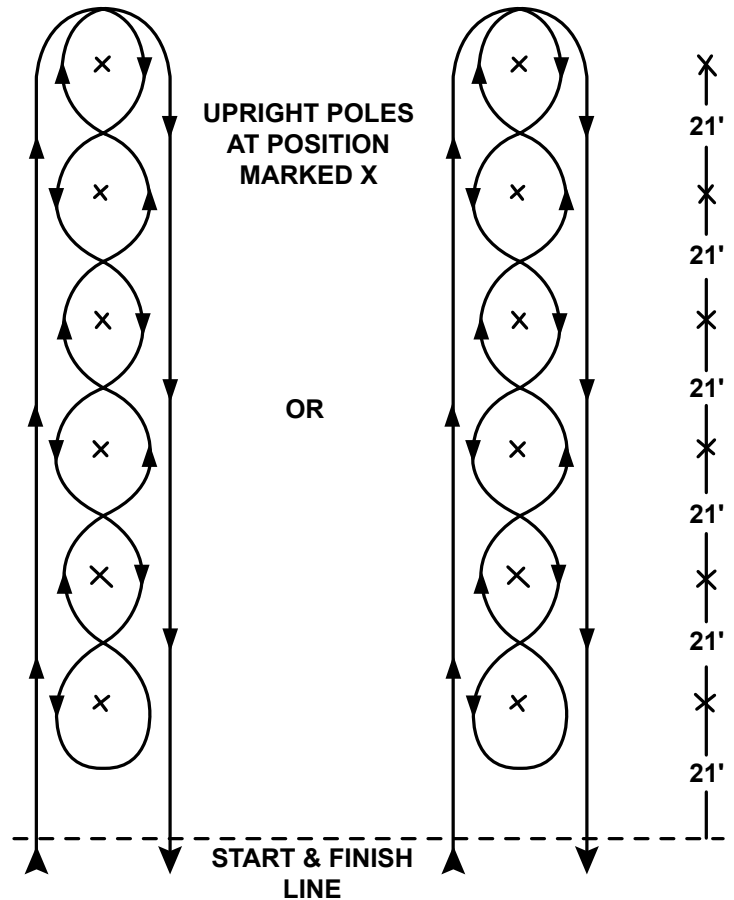

c. Pole Bending

1. Horses must maneuver through six (6) poles at speed following the pattern below. Poles are placed in a straight line 21 feet apart and the first pole is 21 feet from the starting line. Poles should be six (6) feet high and set on top of the ground with bases 10-14 inches in diameter. If ring size requires it, the pattern may be modified by shortening the distance equally among the poles and finish line. The course must have ample room to turn and stop. Contestants may start on either side of the line of poles.

All Riding Pattern diagrams are reprinted with permission from the American Quarter Horse Association. American Quarter Horse Association ©

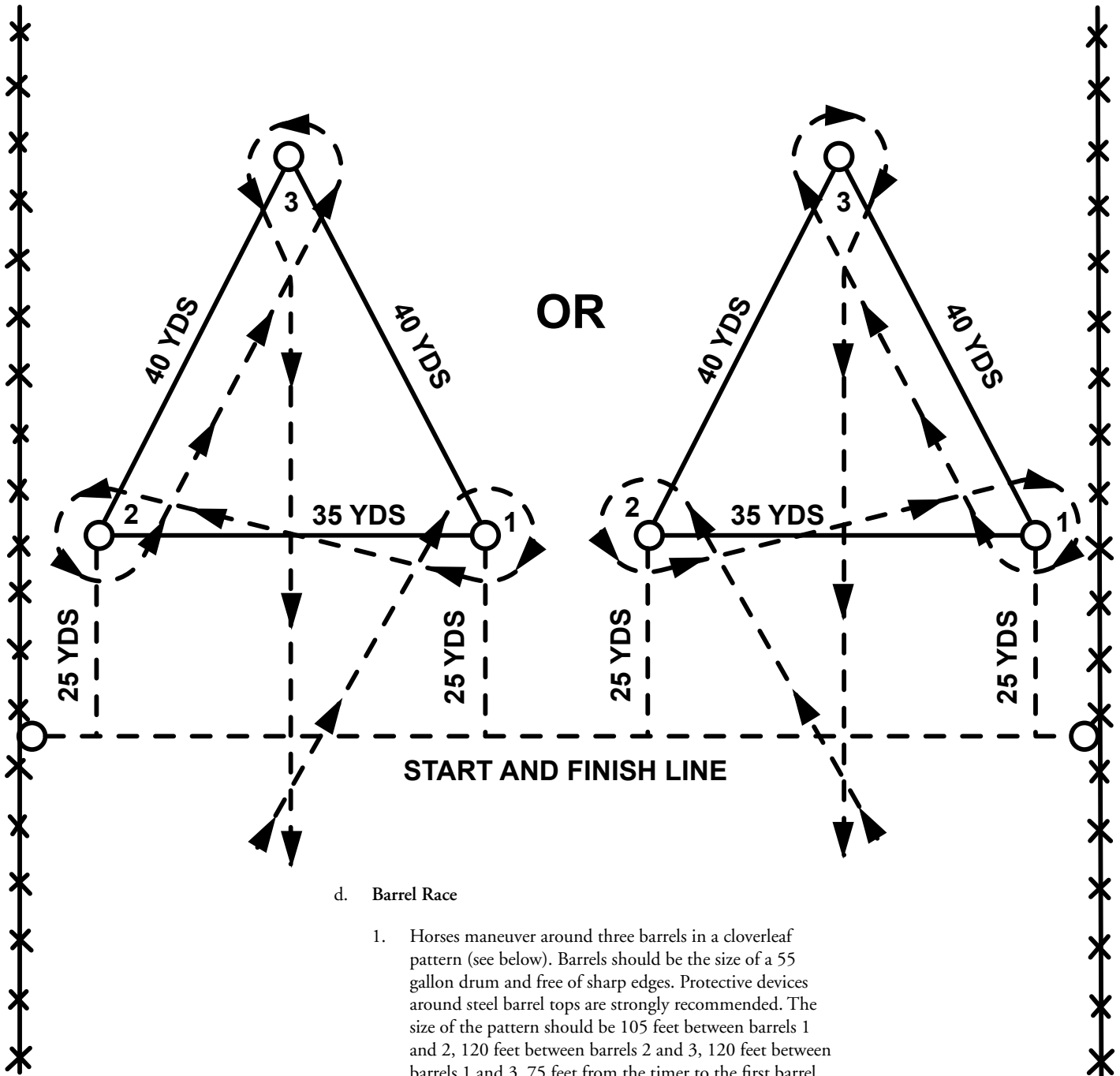

d. Barrel Race

1. Horses maneuver around three barrels in a cloverleaf pattern (see below). Barrels should be the size of a 55 gallon drum and free of sharp edges. Protective devices around steel barrel tops are strongly recommended. The size of the pattern should be 105 feet between barrels 1 and 2, 120 feet between barrels 2 and 3, 120 feet between barrels 1 and 3, 75 feet from the timer to the first barrel. These distances may be reduced proportionately if space limitations or potential hazards so dictate.
2. Riders have the option of riding either course A or B.
3. Hands or reins may not be used as a whip in this class.

All Riding Pattern diagrams are reprinted with permission from the American Quarter Horse Association. American Quarter Horse Association ©



Appendix A: Western Riding Patterns

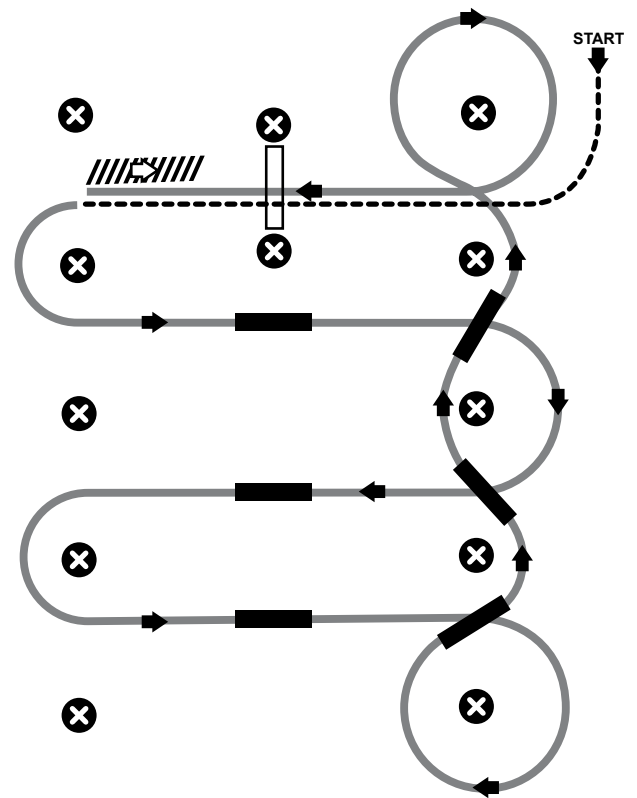
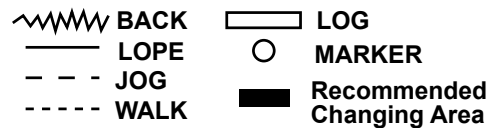
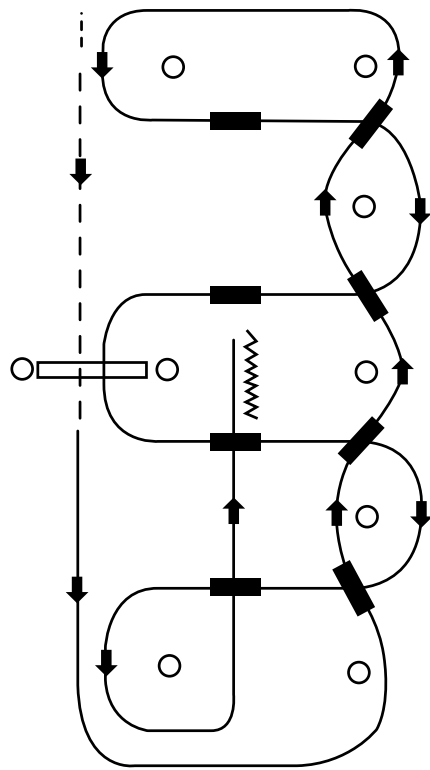

Western Riding Pattern 1

1. Walk at least 15' & jog over log
2. Transition to left & lope around end
3. First line change
4. Second line change
5. Third line change
6. Fourth line change lope around the end of arena
7. First crossing change
8. Second crossing change
9. Lope over log
10. Third crossing change
11. Fourth crossing change
12. Lope up center, stop & back

Western Riding Pattern 2

1. Walk, transition to jog, jog over log
2. Transition to left
3. First crossing change
4. Second crossing change
5. Third crossing change
6. Circle & first line change
7. Second line change
8. Third line change
9. Fourth line change & circle
10. Lope over log
11. Lope, stop & back

All Riding Pattern diagrams are reprinted with permission from the American Quarter Horse Association. American Quarter Horse Association ©



Appendix B: Reining Patterns

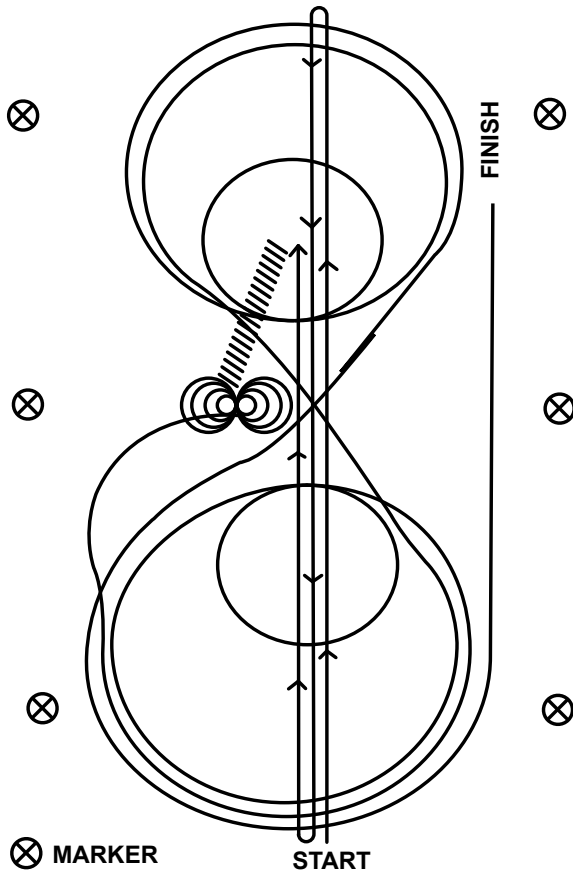

AQHA REINING PATTERN NUMBER 1

1. Run at speed to the far end of the arena past the end marker and do a left rollback—no hesitation.
2. Run to the opposite end of the arena past the end marker and do a right rollback—no hesitation.
3. Run past the center marker and do a sliding stop. Back up to center of the arena or at least 10 feet (3 meters). Hesitate.
4. Complete four spins to the right.
5. Complete four and one-quarter spins to the left so that horse is facing left wall or fence. Hesitate.
6. Beginning on the left lead, complete three circles to the left: the first circle large and fast; the second circle small and slow; the third circle large and fast. Change leads at the center of the arena.
7. Complete three circles to the right: the first circle large and fast; the second circle small and slow; the third circle large and fast. Change leads at the center of the arena.
8. Begin a large fast circle to the left but do not close this circle. Run straight up the right side of the arena past the center marker and do a sliding stop at least 20 feet (6 meters) from wall or fence. Hesitate to demonstrate the completion of the pattern. Rider may drop bridle to the designated judge.

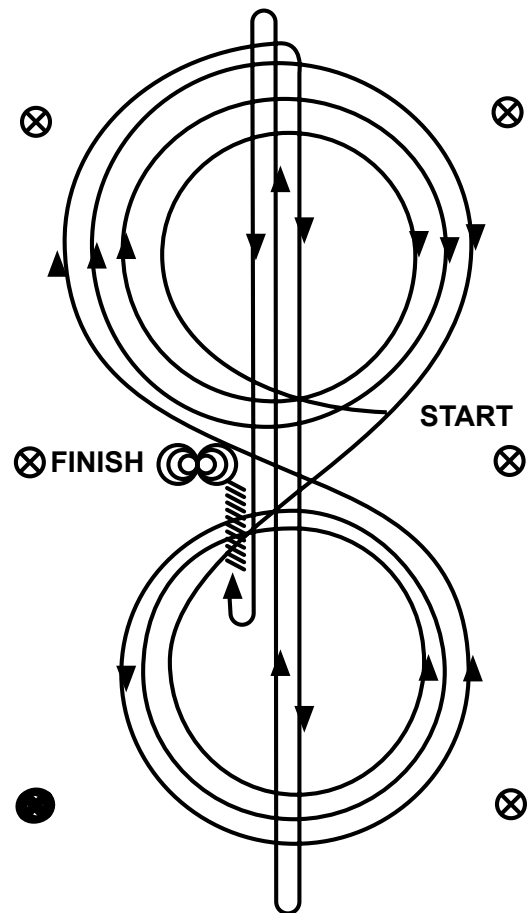

AQHA REINING PATTERN NUMBER 2

- Horse must walk or stop prior to starting pattern. Beginning at the center of the arena facing the left wall or fence.
1. Beginning on the right lead, complete three circles to the right: the first circle small and slow; the next two circles large and fast. Change leads at the center of the arena.
 2. Complete three circles to the left: the first circle small and slow; the next two circles large and fast. Change leads at the center of the arena.
 3. Continue around previous circle to the right. At the top of the circle, run down the middle to the far end of the arena past the end marker and do a right rollback—no hesitation.
 4. Run up the middle to the opposite end of the arena past the end marker and do a left rollback—no hesitation.
 5. Run past the center marker and do a sliding stop. Back up to the center of the arena or at least 10 feet (3 meters). Hesitate.
 6. Complete four spins to the right.
 7. Complete four spins to the left. Hesitate to demonstrate the completion of the pattern. Rider may drop bridle to the designated judge.

All Riding Pattern diagrams are reprinted with permission from the American Quarter Horse Association. American Quarter Horse Association ©



Appendix C: Working Western Pattern

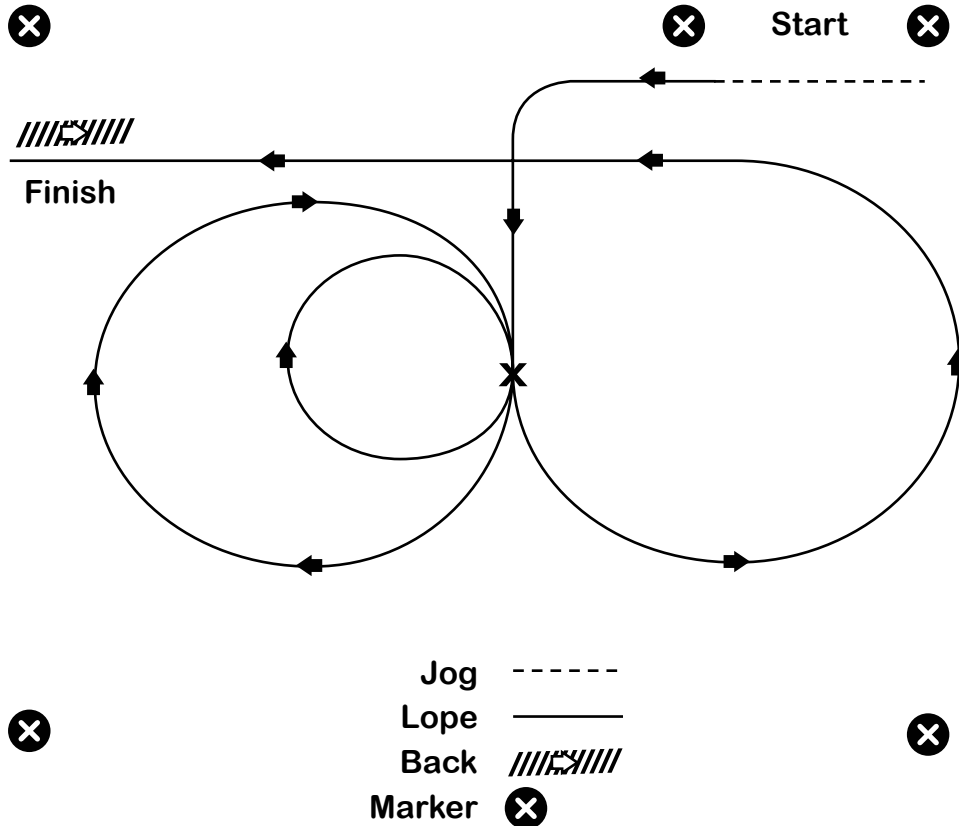

Working Western Pattern

1. Wait just outside gate while the previous horse is completing pattern. Be ready to walk into the ring as soon as the previous horse finishes backing. Wait for judge's acknowledgement before you begin pattern. Pattern should be completed well off the rail.
2. Walk into the ring and pick up a jog at the first cone.
3. At the second cone, pick up the left lead and lope to the center of the ring.
4. Stop at the X area.
5. Do a 360 ° spin to the right.
6. Take the right lead and lope a small, slow circle to the right.
7. Continue loping to the right a large, fast circle to the right staying within the outside cones.
8. Make a simple or flying lead change at the X to the left lead.
9. Lope the beginning of a circle to the left but do not close the circle.
10. Lope toward the exit gate.
11. Stop. Do not go past the marker.
12. Back 5 steps. Exit ring at walk.

Suggested Rule Book Change Form

Please print or type and add additional pages if needed. Please use one form for each suggested change to the Maryland 4-H Horse Show Rule Book.

Date: _____

Name: _____

County: _____

Address: _____

Daytime Phone: _____

E-mail: _____

Location of recommended change: Page _____ Paragraph: _____

Suggested Change: _____

Suggested Wording: _____

Reference Material: _____

Please return the completed form to:
Maryland 4-H Center
8020 Greenmeade Drive
College Park, MD 20740
Fax: 301-314-7146

UNIVERSITY OF
MARYLAND
EXTENSION
Solutions in your community

Issued in furtherance of Cooperative Extension work, acts of May 8 and June 30, 1914, in cooperation with the U.S. Department of Agriculture, University of Maryland, College Park, and local governments. Cheng-i Wei, Director of University of Maryland Extension, University of Maryland.

The University of Maryland is equal opportunity. The University's policies, programs, and activities are in conformance with pertinent Federal and State laws and regulations on nondiscrimination regarding race, color, religion, age, national origin, gender, sexual orientation, marital or parental status, or disability. Inquiries regarding compliance with Title VI of the Civil Rights Act of 1964, as amended; Title IX of the Educational Amendments; Section 504 of the Rehabilitation Act of 1973; and the Americans With Disabilities Act of 1990; or related legal requirements should be directed to the Director of Human Resources Management, Office of the Dean, College of Agriculture and Natural Resources, Symons Hall, College Park, MD 20742.

The University of Maryland Extension's programs are open to all citizens without regard to race, color, gender, disability, religion, age, or national origin.